

59J Series

Narrow Style Push Plate Switches

INSTALLATION INSTRUCTIONS

Section 1

General Description

The 59J Series push plate switches are designed to provide unobtrusive, reliable activation of any automatic door at the door frame. The unique design of these switches includes interchangeable 1 1/2" x 4 1/4" face plates that attach to a 1 11/16" x 4 1/2" stainless steel back plate assembly.

Section 2

Basic Installation

- 1) Make the required cutout in the door frame.

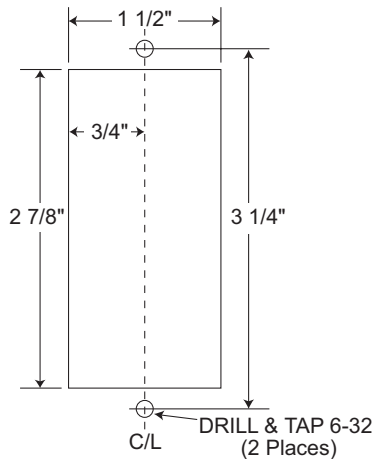

- 2) Remove the face plate from the back plate assembly.
- 3) Connect the necessary signal wires to the appropriate switch contacts on the micro-switch —standard connections are COM and N.O. (Fig. 1)

FIGURE 1

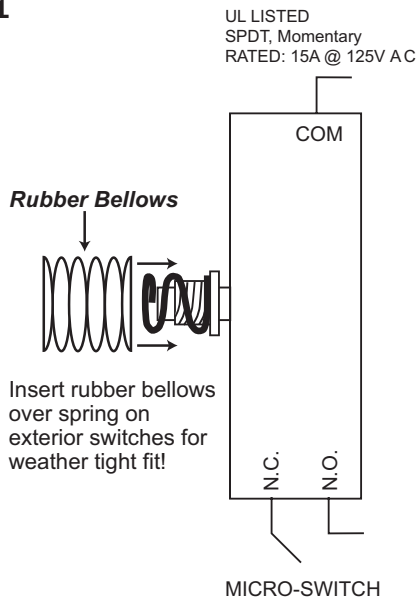

- 4) Attach the back plate assembly in the cutout prepared in step 1 with the 6-32 x 1" screws provided. **Do Not Over Tighten!** (Fig. 2)

FIGURE 2

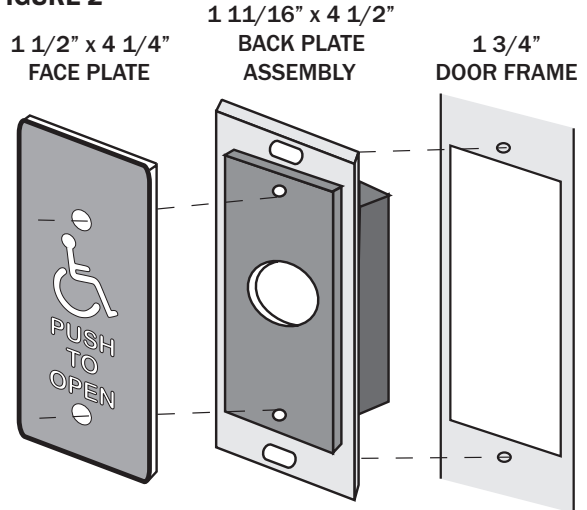

- 5) Insert rubber bellow over spring (exterior applications) (Fig. 1).
- 6) Reinstall the face plate.



NOTICE: For surface mounting applications, order the 1010 surface mount box.



NOTICE: For radio control applications, order the CP/TX-J transmitter with surface mount box.



NOTICE: For applications where a greater level of weather protection is desired, install the rubber bellow (Fig. 1) provided in the screw pack.



NOTICE: Tamper Proof "Spanner" screws for the face plate are included in the screw pack.

SCREW PACK CONTENTS:

- 2 - 6/32" x 1/4" Spanner (tamper-proof) Face Plate Screws
- 1 - Spanner Key
- 2 - 6/32" x 1" Mounting Screws
- 1 - Rubber Bellow for Added Weather Protection
- 2 - Flag Type Wire Connectors

For further technical assistance, contact the factory at 1-800-842-2545.